

# 3.4 Flugfiguren Newcomer-Programm 2010

**Figur N1:**  
Schweben Rück-/Vorwärts

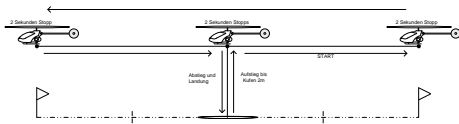

**Figur N3:**  
Stehendes M

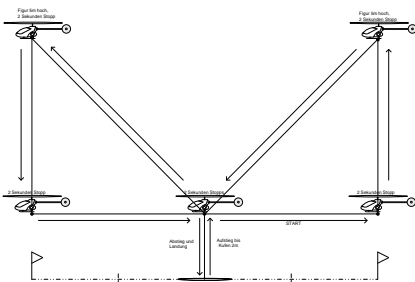

**Figur N5:**  
Halbkreis

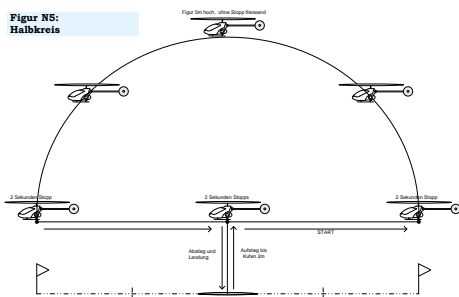

**Figur N7:**  
180° Turn

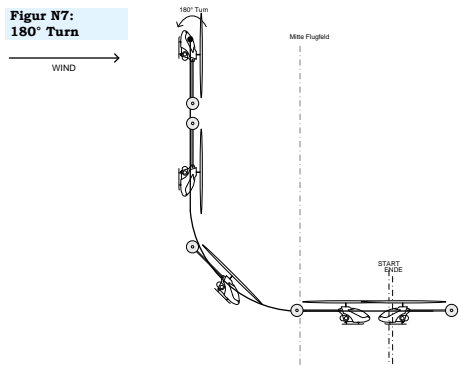

**Figure N9:**  
Looping

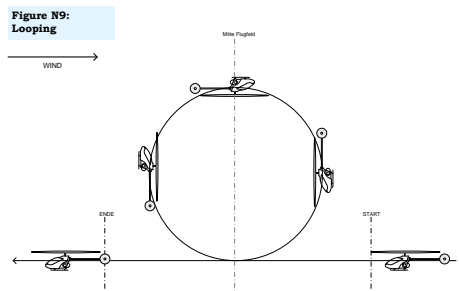

**Figur N2:**  
Umgekehrtes Dreieck

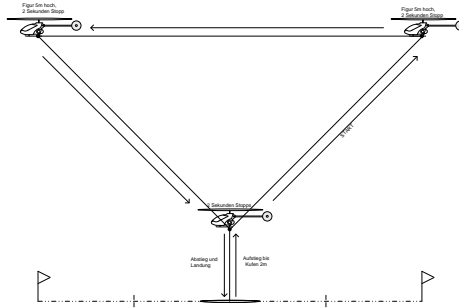

**Figur N4:**  
Diamant

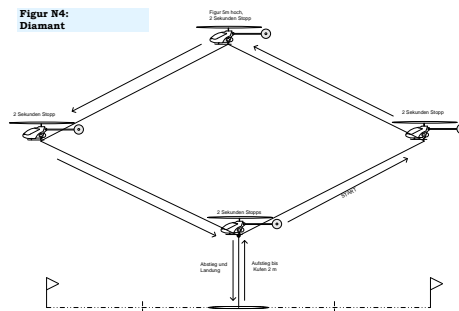

**Figur N6:**  
Startvolte

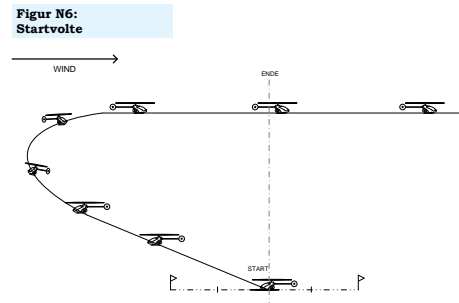

**Figur N8:**  
Cobra

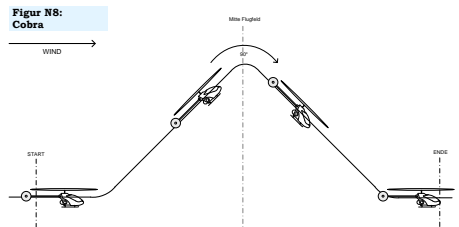

**Figur N10:**  
Gerade Landung

