

2.4 Flugfiguren Promotion-Programm 2010

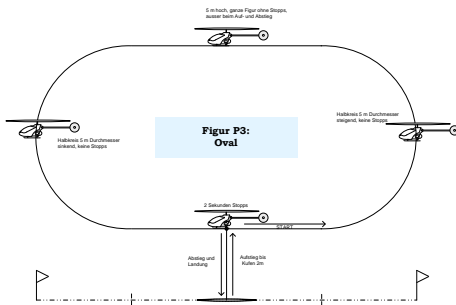

Figur P4:
Doppel Looping

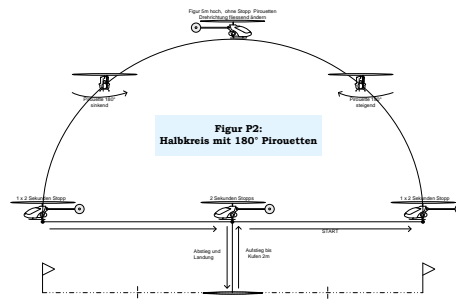
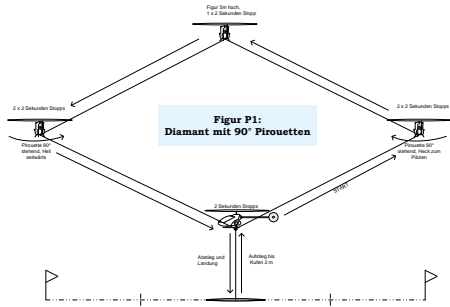
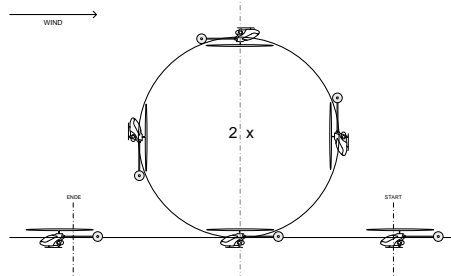

Figur P5:
2 Rollen

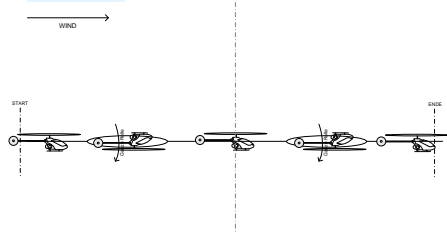

Figur P6:
180° Turn mit
1/2 Rolle abwärts

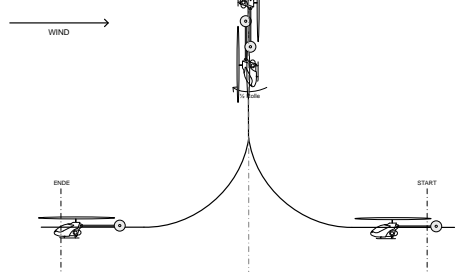

Figur P7:
Messerflug Cobra Rolle

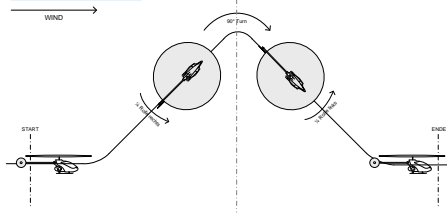

Figur P8:
Oval mit Rückenflug

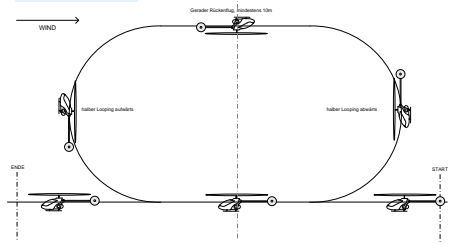

Figur P9b:
180° Autorotation

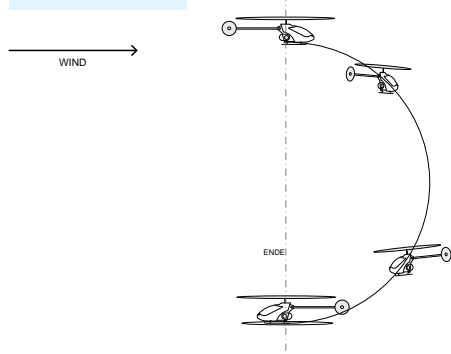

Figur P9a:
Gerade Autorotation

